

RoHS

This products can apply to the SWB Doc NO. QA-3-04-005 of Environmental&Material Management Rules

■ Specifications :

- Voltage rating: 250V AC / DC
- Current rating: 2A AC / DC
- Withstanding voltage: 1000V AC/minute
- Temperature range: -25°C~+85°C
- Insulation resistance: ≥1000MΩ
- Contact resistance: ≤20mΩ
- After environmental testing: ≤30mΩ
- Suitable SWB Terminal 4601T
- Mates With SWB Pin Heade Or Box Header 4601W

4601 H X - 2*XX X - N0 XX
 ① ②③ ④ ⑤ ⑥ ⑦

- ① Series No.
- ② Category: H-HSG
- ③ Appearance type: Blank-Ordinary
- ④ Row No.-Pin No.: 2*XX-2*02P~2*30P
- ⑤ Plug the Pin & special No.:
- ⑥ Material: N0-PA66 UL 94V-0
- ⑦ Color: Blank-Natural Color
HF-Halogen Free

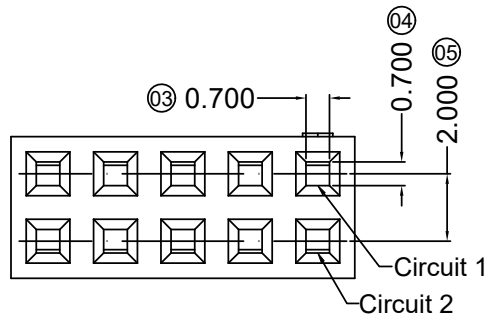
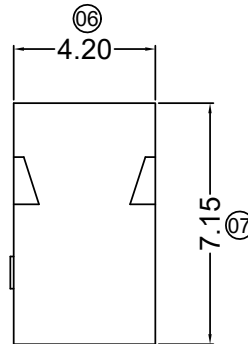
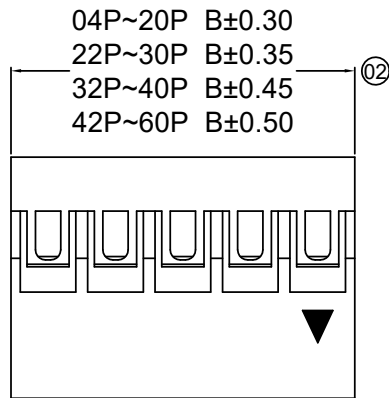
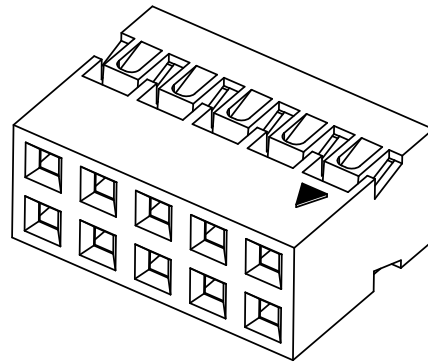
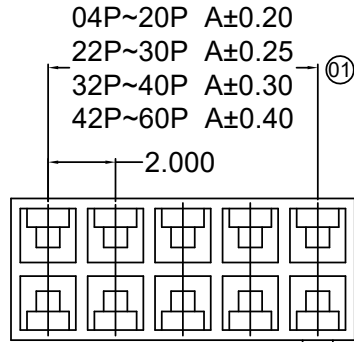

Poles	Dimensions (mm)		Poles	Dimensions (mm)	
	A	B		A	B
2*02	2.00	4.20	2*17	32.00	34.20
2*03	4.00	6.20	2*18	34.00	36.20
2*04	6.00	8.20	2*19	36.00	38.20
2*05	8.00	10.20	2*20	38.00	40.20
2*06	10.00	12.20	2*21	40.00	42.20
2*07	12.00	14.20	2*22	42.00	44.20
2*08	14.00	16.20	2*23	44.00	46.20
2*09	16.00	18.20	2*24	46.00	48.20
2*10	18.00	20.20	2*25	48.00	50.20
2*11	20.00	22.20	2*26	50.00	52.20
2*12	22.00	24.20	2*27	52.00	54.20
2*13	24.00	26.20	2*28	54.00	56.20
2*14	26.00	28.20	2*29	56.00	58.20
2*15	28.00	30.20	2*30	58.00	60.20
2*16	30.00	32.20			

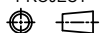
					GENERAL TOLERANCE .X ±0.30 .XX ±0.20 .XXX ±0.10 X.° ±2°				 东莞市思索连接器有限公司 SWB CONNECTORS CO.,LTD				PART NO. 4601H-2*XX-N0XX							
					APPROVAL Robing				CHECK YYting				DRAWN Jova				DATE 2007/05/03			
					PROJECT 															
2020.8.19	E	EN20200318002	Update Drawing Frame	YYting	Robing					TITLE 2.00mm Crimp Style Connectors										
DATE	REV	ECN NO.	DESCRIPTION	MODIFY	APPROVAL					UNIT mm SCALE 1:1 SHEET 1/1 REV E NUMBER A-057										

RoHS

This products can apply to the SWB Doc NO. QA-3-04-005 of Environmental&Material Management Rules

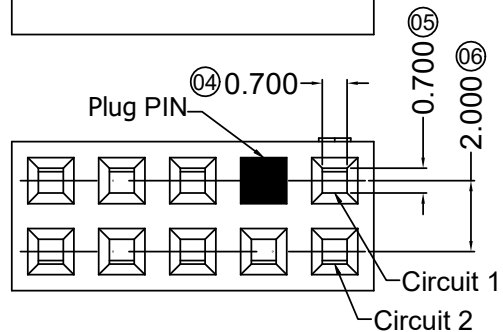
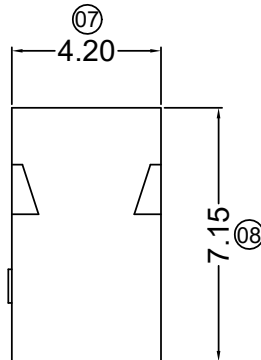
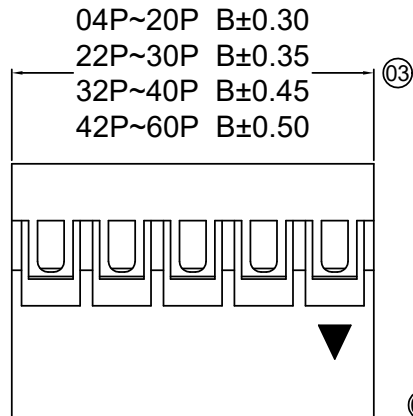
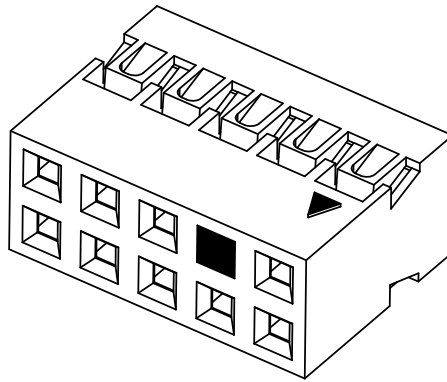
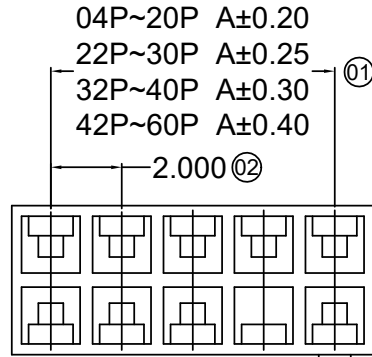

■ Specifications :

- Voltage rating: 250V AC / DC
- Current rating: 2A AC / DC
- Withstanding voltage: 1000V AC/minute
- Temperature range: -25°C~+85°C
- Insulation resistance: ≥1000MΩ
- Contact resistance: ≤20mΩ
- After environmental testing: ≤30mΩ
- Suitable SWB Terminal 4601T
- Mates With SWB Pin Heade Or Box Header 4601W

4601 H X - 2*XX KXX - N0 XX
 ① ②③ ④ ⑤ ⑥ ⑦

- ① Series No.
- ② Category: H-HSG
- ③ Appearance type: Blank-Ordinary
- ④ Row No.-Pin No.: 2*XX-2*02P~2*30P
- ⑤ Plug the Pin & special No.: K-Plug PIN
- ⑥ Material: N0-PA66 UL 94V-0
- ⑦ Color: Blank-Natural Color
HF-Halogen Free

Poles	Dimensions (mm)		Poles	Dimensions (mm)	
	A	B		A	B
2*02	2.00	4.20	2*17	32.00	34.20
2*03	4.00	6.20	2*18	34.00	36.20
2*04	6.00	8.20	2*19	36.00	38.20
2*05	8.00	10.20	2*20	38.00	40.20
2*06	10.00	12.20	2*21	40.00	42.20
2*07	12.00	14.20	2*22	42.00	44.20
2*08	14.00	16.20	2*23	44.00	46.20
2*09	16.00	18.20	2*24	46.00	48.20
2*10	18.00	20.20	2*25	48.00	50.20
2*11	20.00	22.20	2*26	50.00	52.20
2*12	22.00	24.20	2*27	52.00	54.20
2*13	24.00	26.20	2*28	54.00	56.20
2*14	26.00	28.20	2*29	56.00	58.20
2*15	28.00	30.20	2*30	58.00	60.20
2*16	30.00	32.20			

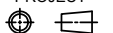
						GENERAL TOLERANCE		 东莞市思索连接器有限公司 SWB CONNECTORS CO.,LTD				PART NO.				
						.X ±0.30						4601H-2*XXKXX-N0				
						.XX ±0.20						TITLE				
						.XXX ±0.10						2.00mm Crimp Style Connectors				
						X.° ±2°						UNIT				
2020.8.19	E	EN20200318002	Update Drawing Frame	YYting	Robing	PROJECT		APPROVAL	CHECK	DRAWN	DATE	SCALE	SHEET	REV	NUMBER	
DATE	REV	ECN NO.	DESCRIPTION	MODIFY	APPROVAL			Robing	YYting	Jova	2007/05/03	mm	1:1	1/1	E	A-057



东莞市思索连接器有限公司
SWB CONNECTORS CO.,LTD

PART NO.				
4601H-2*XXKXX-N0				
TITLE				
2.00mm Crimp Style Connectors				
UNIT	SCALE	SHEET	REV	NUMBER
mm	1:1	1/1	E	A-057

RoHS

This products can apply to the SWB Doc NO. QA-3-04-005 of Environmental&Material Management Rules

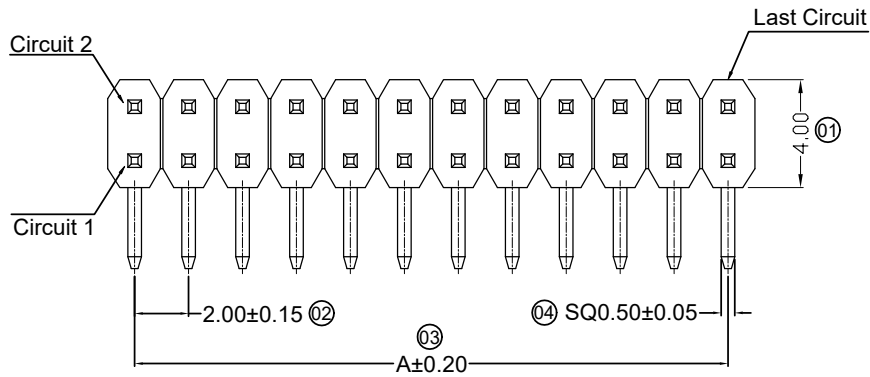

- Specifications :
- Voltage rating: 250V AC / DC
 - Current rating: 2A AC / DC
 - Withstanding voltage: 1000V AC/minute
 - Temperature range: -40°C~+105°C
 - Insulation resistance: ≥1000MΩ
 - Contact resistance: ≤20mΩ
 - After environmental testing: ≤30mΩ
 - Material(Pin):Brass
 - Mates with SWB Female Header: 4601FX

4601 W R X - 2*XX X - XX V01 XX - 01
 ① ② ③ ④ ⑤ ⑥ ⑦ ⑧ ⑨ ⑩

- ① Series No.
- ② Category: W-wafer
- ③ Connector Type: R- Right Angle 90°
- ④ Mounting Type: Blank-DIP
- ⑤ Row No.-Pin No Per Row: 2*XX-2*02P~2*40P
- ⑥ Special No.: Blank-Ordinary
- ⑦ Material: 6T-PA6T 94V-0 ;9T-PA9T 94V-0
- ⑧ Plating Code: V01- Gold Flash
- ⑨ Color: Blank-Black Color
- ⑩ 01-5.50/2.00/3.00

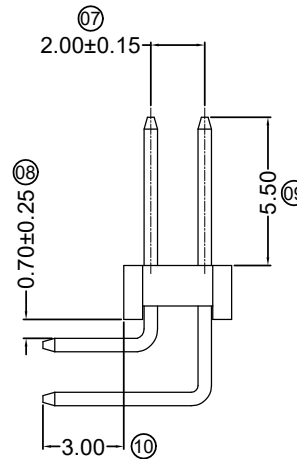
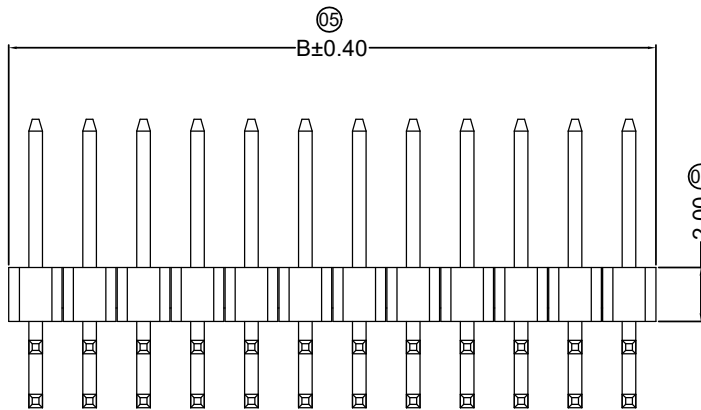

Poles	Dimensions (mm)		Poles	Dimensions (mm)		Poles	Dimensions (mm)	
	A	B		A	B		A	B
2*02	2.00	4.00	2*15	28.00	30.00	2*28	54.00	56.00
2*03	4.00	6.00	2*16	30.00	32.00	2*29	56.00	58.00
2*04	6.00	8.00	2*17	32.00	34.00	2*30	58.00	60.00
2*05	8.00	10.00	2*18	34.00	36.00	2*31	60.00	62.00
2*06	10.00	12.00	2*19	36.00	38.00	2*32	62.00	64.00
2*07	12.00	14.00	2*20	38.00	40.00	2*33	64.00	66.00
2*08	14.00	16.00	2*21	40.00	42.00	2*34	66.00	68.00
2*09	16.00	18.00	2*22	42.00	44.00	2*35	68.00	70.00
2*10	18.00	20.00	2*23	44.00	46.00	2*36	70.00	72.00
2*11	20.00	22.00	2*24	46.00	48.00	2*37	72.00	74.00
2*12	22.00	24.00	2*25	48.00	50.00	2*38	74.00	76.00
2*13	24.00	26.00	2*26	50.00	52.00	2*39	76.00	78.00
2*14	26.00	28.00	2*27	52.00	54.00	2*40	78.00	80.00

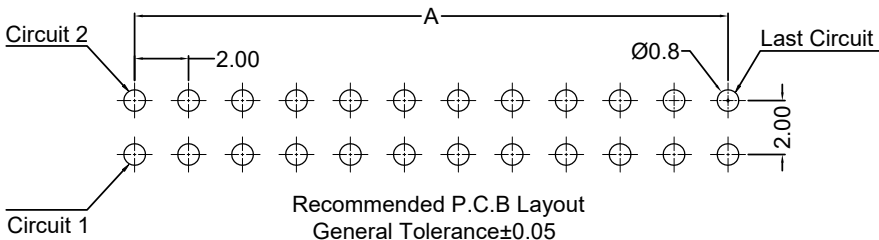

					GENERAL TOLERANCE				PART NO. 4601WR-2*XX-XXV01-01			
					.X ±0.30				TITLE 2.00 mm Pin Header connectors			
					.XX ±0.20				UNIT mm			
					.XXX ±0.10				SCALE 1:1			
					X.° ±2°				SHEET 1/1			
2020.8.19	B	EN20200318002	Update Drawing Frame	YYting	Robing	APPROVAL		CHECK	DRAWN	DATE	REV B	NUMBER A-268
DATE	REV	ECN NO.	DESCRIPTION	MODIFY	APPROVAL	Robing	YYting	Mandy	2020/04/22			



东莞市思索连接器有限公司

SWB CONNECTORS CO.,LTD

PART NO. 4601WR-2*XX-XXV01-01

TITLE 2.00 mm Pin Header connectors

UNIT mm SCALE 1:1 SHEET 1/1 REV B NUMBER A-268