

RoHS

This products can apply to the SWB Doc NO. QA-3-04-005 of Environmental&Material Management Rules

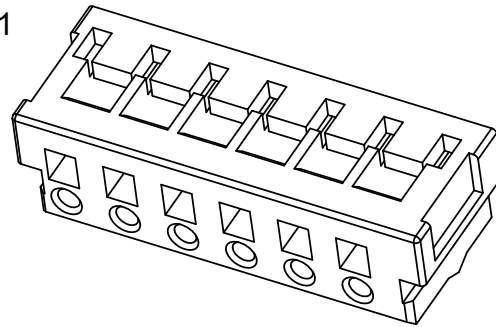
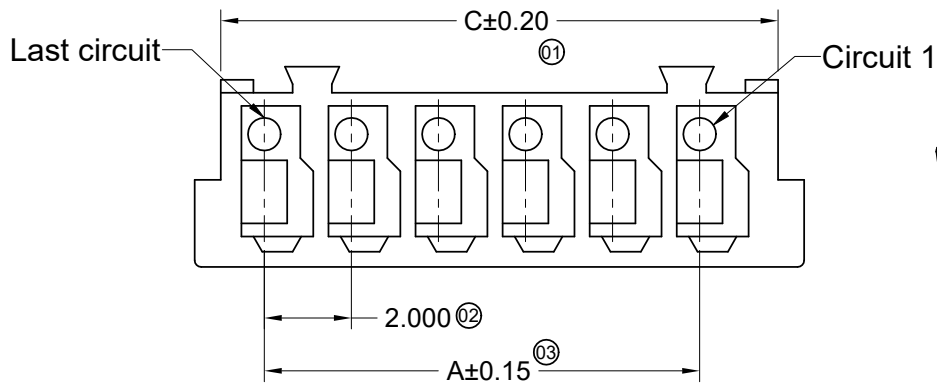

■ Specifications :

- Voltage rating: 125V AC / DC
- Current rating: 3A AC / DC
- Withstanding voltage: 1000V AC/minute
- Temperature range: -25°C~+85°C
- Insulation resistance: ≥1000MΩ
- Contact resistance: ≤10mΩ
- After environmental testing: ≤20mΩ
- Suitable SWB Terminal: 2004T
- Mates With SWB Wafer: 2004W

2004 H X-XX X-N0 HF

① ②③ ④ ⑤ ⑥ ⑦

- ① Series No.
- ② Category: H-HSG
- ③ Appearance type: Blank-Ordinary
- ④ Row No.-Pin No.: XX-02P~16P
- ⑤ Special No.: Blank-Ordinary
- ⑥ Material: N0-PA 66 94V-0
- ⑦ HF-Halogen Free

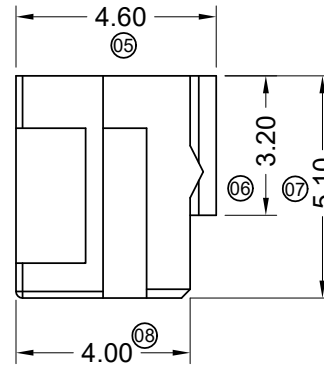
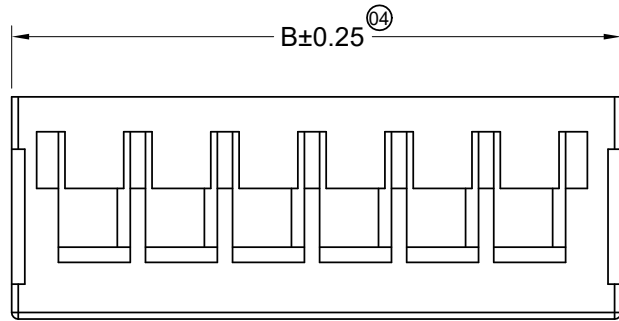

Poles	Dimensions (mm)		
	A	B	C
02	2.00	6.00	4.80
03	4.00	8.00	6.80
04	6.00	10.00	8.80
05	8.00	12.00	10.80
06	10.00	14.00	12.80
07	12.00	16.00	14.80
08	14.00	18.00	16.80
09	16.00	20.00	18.80
10	18.00	22.00	20.80
11	20.00	24.00	22.80
12	22.00	26.00	24.80
13	24.00	28.00	26.80
14	26.00	30.00	28.80
15	28.00	32.00	30.80
16	30.00	34.00	32.80

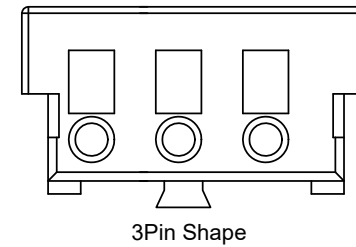
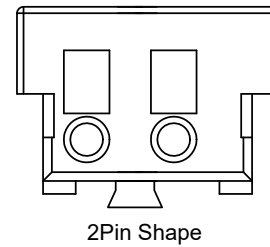
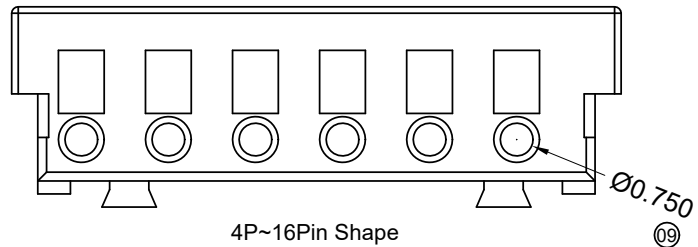

DATE	REV	ECN NO.	DESCRIPTION	MODIFY	APPROVAL
2020/03/19	F	EN20200319003	Update Drawing Frame	Alan qin	Robing
2015/04/24	E		Modify the drawing frame format	jian.He	Jova

GENERAL TOLERANCE	
.X	±0.30
.XX	±0.20
.XXX	±0.10
X.°	±2°

**东莞市思索连接器有限公司**  
**SWB CONNECTORS CO.,LTD**  
 APPROVAL: Robing, CHECK: Alan qin, DRAWN: Wuxiaotao, DATE: 2014/07/15

PART NO.				
2004H-XX-N0HF				
TITLE				
2.00mm Crimp Style Connectors				
UNIT	SCALE	SHEET	REV	NUMBER
mm	1:1	1/1	F	A-022

RoHS

This products can apply to the SWB Doc NO. QA-3-04-005 of Environmental&Material Management Rules

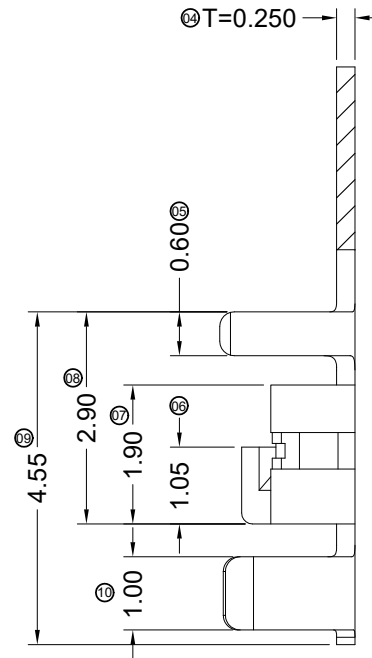
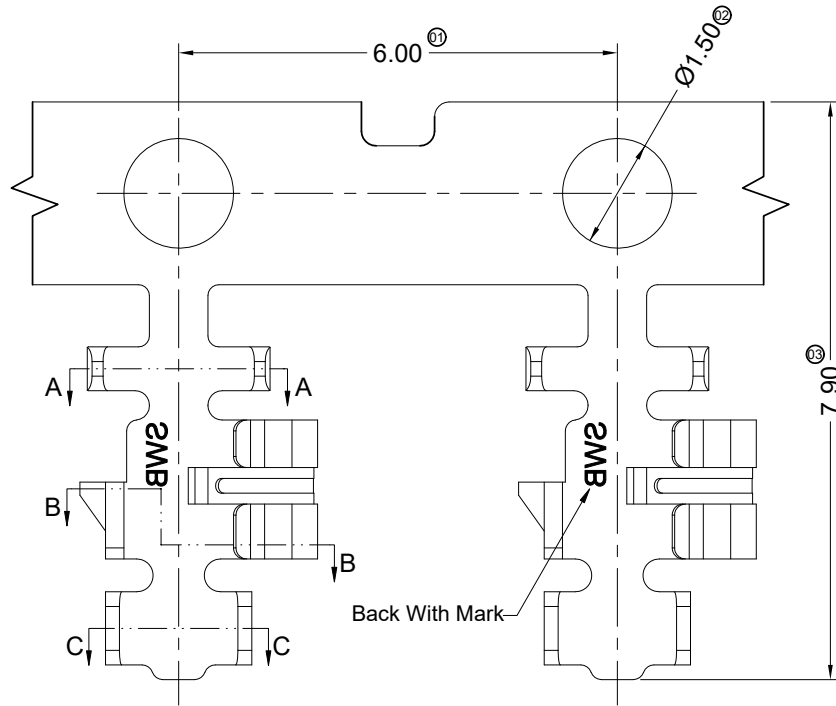

Specifications :

- Voltage rating: 125V AC / DC
- Current rating: 3A AC / DC
- Withstanding voltage: 1000V AC/minute
- Temperature range: -25°C~+85°C
- Insulation resistance: ≥1000MΩ
- Contact resistance: ≤10mΩ
- After environmental testing: ≤20mΩ
- Used In SWB Housing: 2004H
- Wire Range: AWG#24-28
- Insulation O.D.: 1.15mm(Max)

2004 T X-P SN X-X

① ② ③ ④ ⑤ ⑥ ⑦

- ① Series Number
- ② Category: T-terminal
- ③ Shape: Blank-ordinary
- ④ Material: P-Phosphor bronze
- ⑤ Plating Code: SN-Bright tin
- ⑥ Plating method: Blank-Stamping before plating
- ⑦ Mold No./Mark/Special No.: Blank-With "SWB" Mark

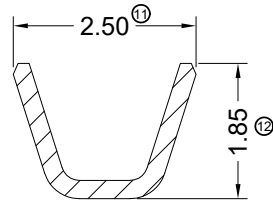

SECTION: A-A  
SCALE: 1:1

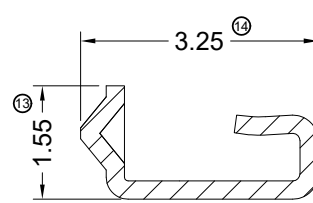

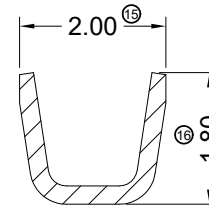

SECTION: B-B  
SCALE: 1:1

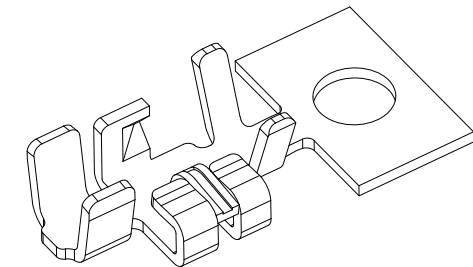

SECTION: C-C  
SCALE: 1:1



						 <b>东莞市思索连接器有限公司</b> <b>SWB CONNECTORS CO.,LTD</b>				<b>PART NO.</b> 2004T-PSN				
						<b>APPROVAL</b> <b>CHECK</b> <b>DRAWN</b> <b>DATE</b>				<b>TITLE</b> 2.00mm Crimp Style Connectors				
						Jova Lau    W.X.T    Wuxiaotao    2014/07/24				UNIT    SCALE    SHEET    REV    NUMBER mm    1:1    1/1    G    A-275				
2020/03/19	G	EN20200319003	Update Drawing Frame	Alan qin	Robing									
2015/09/14	F		Modified to take Mark materials issue	Wuxiaotao	Wuxiaotao									
DATE	REV	ECN NO.	DESCRIPTION	MODIFY	APPROVAL									

GENERAL TOLERANCE	
.X	±0.30
.XX	±0.20
.XXX	±0.10
X.°	±2°
PROJECT	
	

RoHS

This products can apply to the SWB Doc NO. QA-3-04-005 of Environmental&Material Management Rules

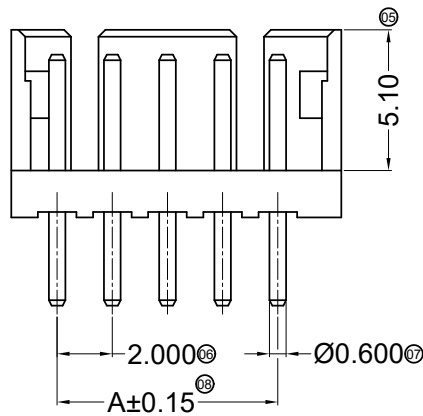
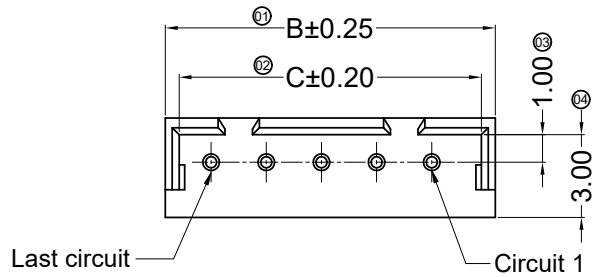

04P~16P Double Gap  
Scale 1:1

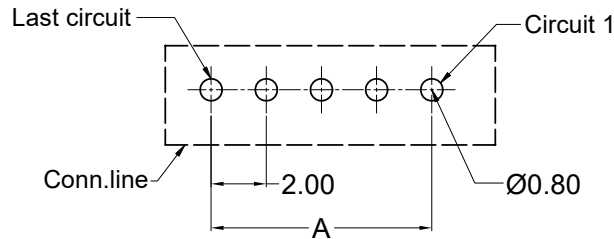

Recommended P.C.B Layout  
General Tolerance±0.05

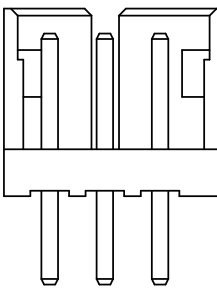
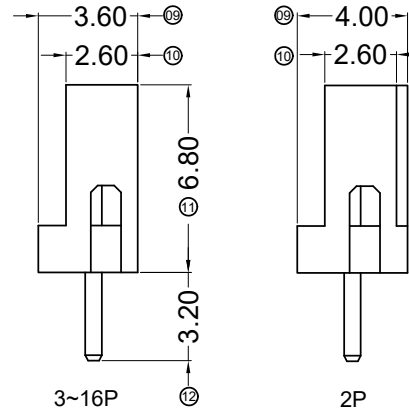
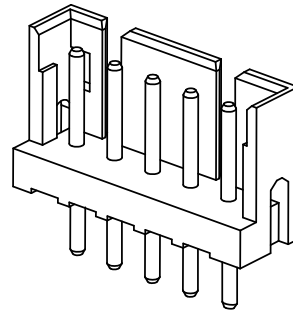

02P~03P Single Gap  
Scale 1:1

Specifications :

- Voltage rating: 125V AC / DC
- Current rating: 3A AC / DC
- Withstanding voltage: 1000V AC/minute
- Temperature range: -25°C~+85°C
- Insulation resistance: ≥1000MΩ
- Contact resistance: ≤10mΩ
- After environmental testing: ≤20mΩ
- Material(Pin): Brass
- Mates With SWB Housing: 2004H

2004 W V X-XX NK -N0 SN XX  
① ② ③ ④ ⑤ ⑥ ⑦ ⑧ ⑨

- ① Series No.
- ② Category: W-Wafer
- ③ Connector Type: V-Straight 180°
- ④ Mounting Type: Blank-DIP
- ⑤ Row No.-Pin No.: XX-02P~16P
- ⑥ Special No.: NK-Without Kink
- ⑦ Material: N0-PA66 94V-0
- ⑧ Plating Code: SN-Bright Tin Plating
- ⑨ Color : Blank-Natural Color



Poles	Dimensions (mm)			Poles	Dimensions (mm)		
	A	B	C		A	B	C
02	2.00	5.96	4.96	10	18.00	21.96	20.96
03	4.00	7.96	6.96	11	20.00	23.96	22.96
04	6.00	9.96	8.96	12	22.00	25.96	24.96
05	8.00	11.96	10.96	13	24.00	27.96	26.96
06	10.00	13.96	12.96	14	26.00	29.96	28.96
07	12.00	15.96	14.96	15	28.00	31.96	30.96
08	14.00	17.96	16.96	16	30.00	33.96	32.96
09	16.00	19.96	18.96				

2020/03/06	H	EN20200306001	Revise the drawing with the actual product	Mandy	Robing	 <b>东莞市思索连接器有限公司</b> SWB CONNECTORS CO.,LTD	PART NO. 2004WV-XXNK-N0SN			
2015/04/24	G		Modify the drawing frame format	jian.He	Jova		TITLE 2.00mm Crimp Style Connectors			
2014/07/22	F		Modify the drawing frame format	Wuxiaotao	Jova		APPROVAL	CHECK	DRAWN	DATE
DATE	REV	ECN NO.	DESCRIPTION	MODIFY	APPROVAL		Jova Lau	W.X.T	Wuxiaotao	2014/07/22
				PROJECT		UNIT SCALE SHEET REV NUMBER mm 1:1 1/1 H A-000				

RoHS

This products can apply to the SWB Doc NO. QA-3-04-005 of Environmental&Material Management Rules

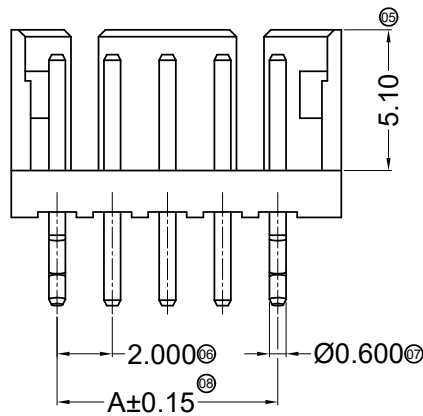
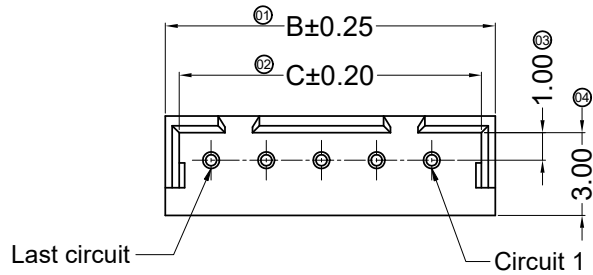

04P~16P Double Gap  
Scale 1:1

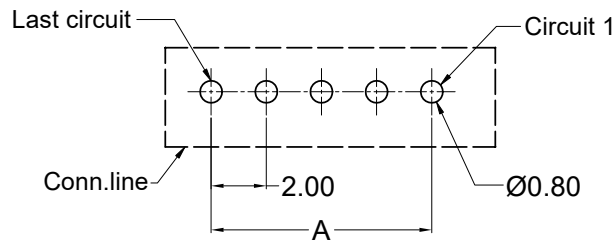

Recommended P.C.B Layout  
General Tolerance±0.05

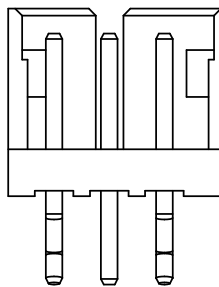
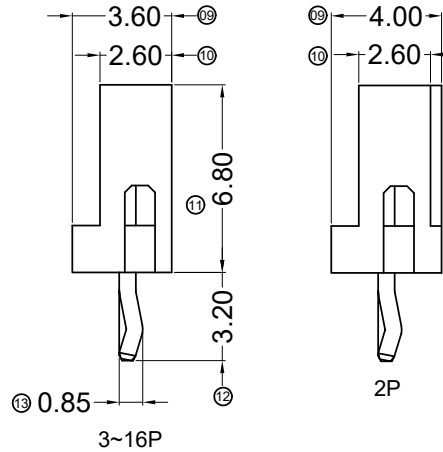
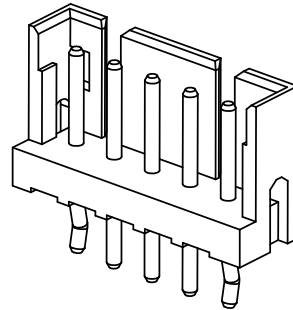

02P~03P Single Gap  
Scale 1:1

Specifications :

- Voltage rating: 125V AC / DC
- Current rating: 3A AC / DC
- Withstanding voltage: 1000V AC/minute
- Temperature range: -25°C~+85°C
- Insulation resistance: ≥1000MΩ
- Contact resistance: ≤10mΩ
- After environmental testing: ≤20mΩ
- Material(Pin): Brass
- Mates With SWB Housing: 2004H

2004 W V X-XX X -N0 SN XX  
① ② ③ ④ ⑤ ⑥ ⑦ ⑧ ⑨

- ① Series No.
- ② Category: W-Wafer
- ③ Connector Type: V-Straight 180°
- ④ Mounting Type: Blank-DIP
- ⑤ Row No.-Pin No.: XX-02P~16P
- ⑥ Special No.: Blank-With Kink
- ⑦ Material: N0-PA66 94V-0
- ⑧ Plating Code: SN-Bright Tin Plating
- ⑨ Color : Blank-Natural Color



Poles	Dimensions (mm)			Poles	Dimensions (mm)		
	A	B	C		A	B	C
02	2.00	5.96	4.96	10	18.00	21.96	20.96
03	4.00	7.96	6.96	11	20.00	23.96	22.96
04	6.00	9.96	8.96	12	22.00	25.96	24.96
05	8.00	11.96	10.96	13	24.00	27.96	26.96
06	10.00	13.96	12.96	14	26.00	29.96	28.96
07	12.00	15.96	14.96	15	28.00	31.96	30.96
08	14.00	17.96	16.96	16	30.00	33.96	32.96
09	16.00	19.96	18.96				

2020/03/06	H	EN20200306001	Revise the drawing with the actual product	Mandy	Robing	GENERAL TOLERANCE .X ±0.30 .XX ±0.20 .XXX ±0.10 X.° ±2° PROJECT 	东莞市思索连接器有限公司 SWB CONNECTORS CO.,LTD	PART NO. 2004WV-XX-N0SN						
2015/04/24	G		Modify the drawing frame format	jian.He	Jova			TITLE 2.00mm Crimp Style Connectors						
2014/07/22	F		Modify the drawing frame format	Wuxiaotao	Jova			APPROVAL	CHECK	DRAWN	DATE			
DATE	REV	ECN NO.	DESCRIPTION	MODIFY	APPROVAL	Jova Lau	W.X.T	Wuxiaotao	2014/07/22	UNIT	SCALE	SHEET	REV	NUMBER
						mm	1:1	1/1	H	A-000				

RoHS

This products can apply to the SWB Doc NO. QA-3-04-005 of Environmental&Material Management Rules

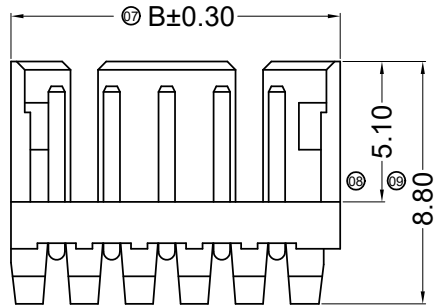
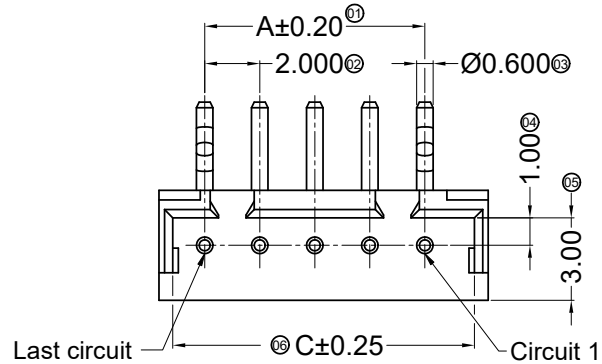

04P~16P Double Gap  
Scale 1:1

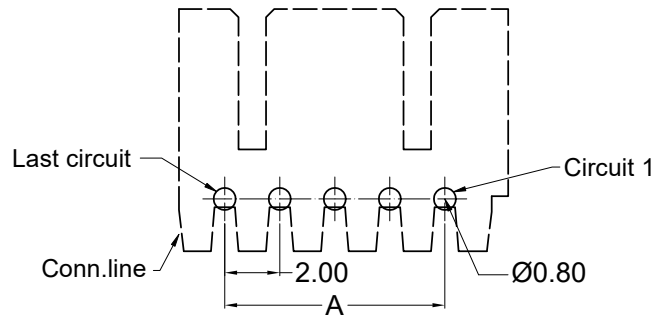

Recommended P.C.B Layout  
General Tolerance±0.05

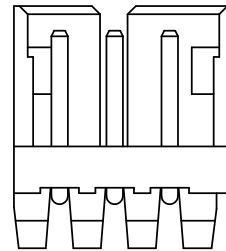
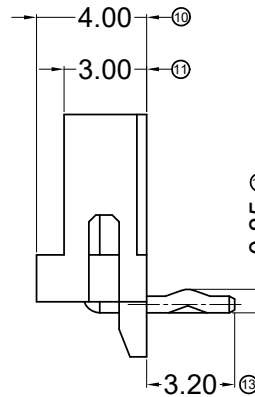
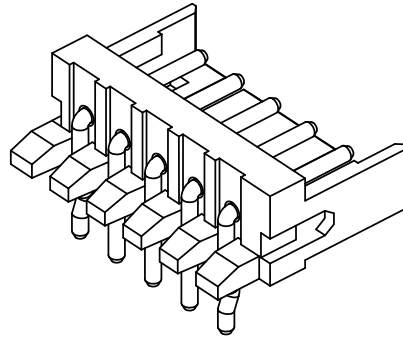

02P~03P Single Gap  
Scale 1:1



■ Specifications :

- Voltage rating: 125V AC / DC
- Current rating: 3A AC / DC
- Withstanding voltage: 1000V AC/minute
- Temperature range: -25°C~+85°C
- Insulation resistance: ≥1000MΩ
- Contact resistance: ≤10mΩ
- After environmental testing: ≤20mΩ
- Material(Pin): Brass
- Mates With SWB Housing: 2004H

2004 W R X-XX X -N0 SN XX  
① ② ③ ④ ⑤ ⑥ ⑦ ⑧ ⑨

- ① Series No.
- ② Category: W-Wafer
- ③ Connector Type: R-Right Angle 90°
- ④ Mounting Type: Blank-DIP
- ⑤ Row No.-Pin No.: XX-02P~16P
- ⑥ Special No.: Blank-Ordinary
- ⑦ Material: N0-PA66 94V-0
- ⑧ Plating Code: SN-Bright Tin Plating
- ⑨ Color : Blank-Natural Color

Poles	Dimensions (mm)			Poles	Dimensions (mm)		
	A	B	C		A	B	C
02	2.00	5.96	4.96	10	18.00	21.96	20.96
03	4.00	7.96	6.96	11	20.00	23.96	22.96
04	6.00	9.96	8.96	12	22.00	25.96	24.96
05	8.00	11.96	10.96	13	24.00	27.96	26.96
06	10.00	13.96	12.96	14	26.00	29.96	28.96
07	12.00	15.96	14.96	15	28.00	31.96	30.96
08	14.00	17.96	16.96	16	30.00	33.96	32.96
09	16.00	19.96	18.96				

2020/03/06	G	EN20200306001	Revise the drawing with the actual product	Mandy	Robing	<b>东莞市思索连接器有限公司</b> <b>SWB CONNECTORS CO.,LTD</b> APPROVAL    CHECK    DRAWN    DATE Jova Lau    W.X.T    Wuxiaotao    2014/07/16	PART NO. 2004WR-XX-N0SN				
2015/10/12	F		Modify the drawing frame format	Wuxiaotao	Jova		TITLE 2.00 mm Crimp Style Connectors				
2015/04/24	E		Modify the drawing frame format	jian.He	Jova		UNIT SCALE SHEET REV NUMBER				
DATE	REV	ECN NO.	DESCRIPTION	MODIFY	APPROVAL		mm 1:1 1/1 G A-000				

RoHS

This products can apply to the SWB Doc NO. QA-3-04-005 of Environmental&Material Management Rules

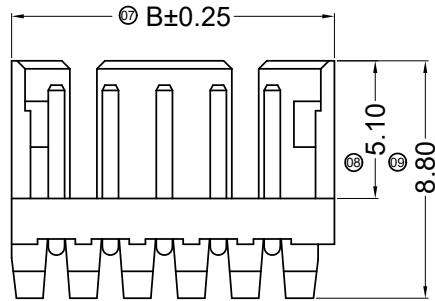
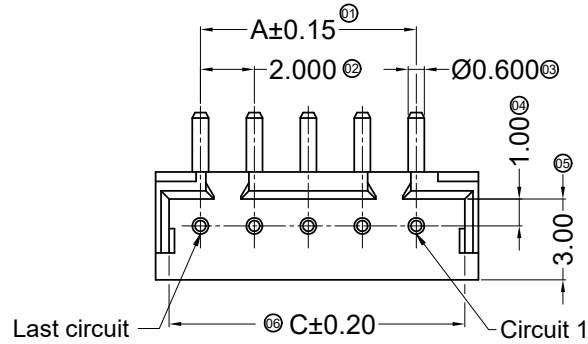

03P~16P Double Gap  
Scale 1:1

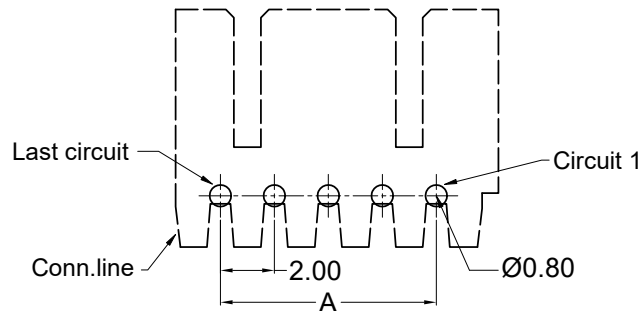

Recommended P.C.B Layout  
General Tolerance±0.05

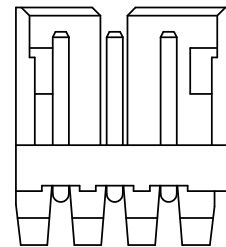
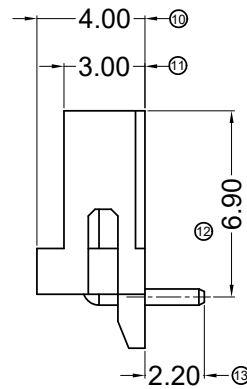
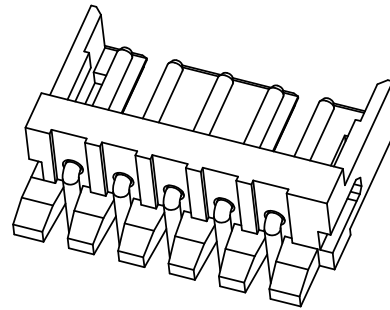

02P~03P Single Gap  
Scale 1:1

Specifications :

- Voltage rating: 125V AC / DC
- Current rating: 3A AC / DC
- Withstanding voltage: 1000V AC/minute
- Temperature range: -25°C~+85°C
- Insulation resistance:≥1000MΩ
- Contact resistance: ≤10mΩ
- After environmental testing: ≤20mΩ
- Material(Pin): Brass
- Mates With SWB Housing: 2004H

2004 W R X-XX A -N0 SN XX  
① ② ③ ④ ⑤ ⑥ ⑦ ⑧ ⑨

- ① Series No.
- ② Category: W-Wafer
- ③ Connector Type: R-Right Angle 90°
- ④ Mounting Type: Blank-DIP
- ⑤ Row No.-Pin No.: XX-02P~16P
- ⑥ Special No.:  
A- Without Kink , Insert =2.20mm
- ⑦ Material: N0-PA66 94V-0
- ⑧ Plating Code: SN-Bright Tin Plating
- ⑨ Color : Blank-Natural Color

Poles	Dimensions (mm)			Poles	Dimensions (mm)		
	A	B	C		A	B	C
02	2.00	5.96	4.96	10	18.00	21.96	20.96
03	4.00	7.96	6.96	11	20.00	23.96	22.96
04	6.00	9.96	8.96	12	22.00	25.96	24.96
05	8.00	11.96	10.96	13	24.00	27.96	26.96
06	10.00	13.96	12.96	14	26.00	29.96	28.96
07	12.00	15.96	14.96	15	28.00	31.96	30.96
08	14.00	17.96	16.96	16	30.00	33.96	32.96
09	16.00	19.96	18.96				



DATE	REV	ECN NO.	DESCRIPTION	MODIFY	APPROVAL	PROJECT	APPROVAL	CHECK	DRAWN	DATE	UNIT	SCALE	SHEET	REV	NUMBER
2020/03/06	G	EN20200306001	Revise the drawing with the actual product	Mandy	Robing	GENERAL TOLERANCE	 东莞市思索连接器有限公司 SWB CONNECTORS CO.,LTD APPROVAL Jova Lau	CHECK	DRAWN	DATE	mm	1:1	1/1	G	A-000
2015/10/12	F		Modify the drawing frame format	Wuxiaotao	.X ±0.30										
2015/04/24	E		Modify the drawing frame format	jian.He	.XX ±0.20										
					.XXX ±0.10										
					X.° ±2°										

PART NO.				
2004WR-XXA-N0SN				
TITLE				
2.00 mm Crimp Style Connectors				
UNIT	SCALE	SHEET	REV	NUMBER
mm	1:1	1/1	G	A-000