

RoHS

This products can apply to the SWB Doc NO. QA-3-04-005 of Environmental&Material Management Rules

F  
E  
D  
C  
B  
A

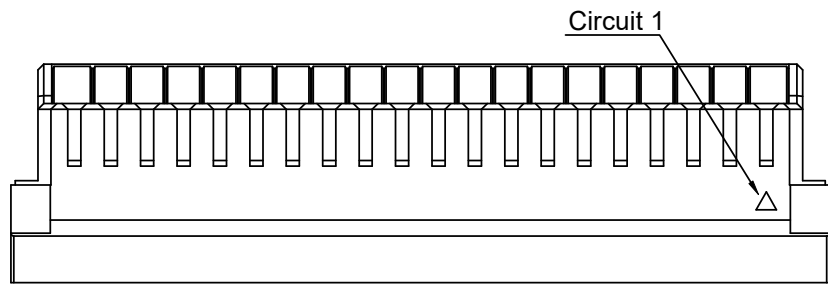
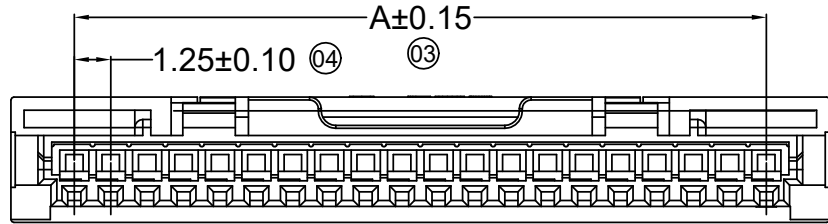
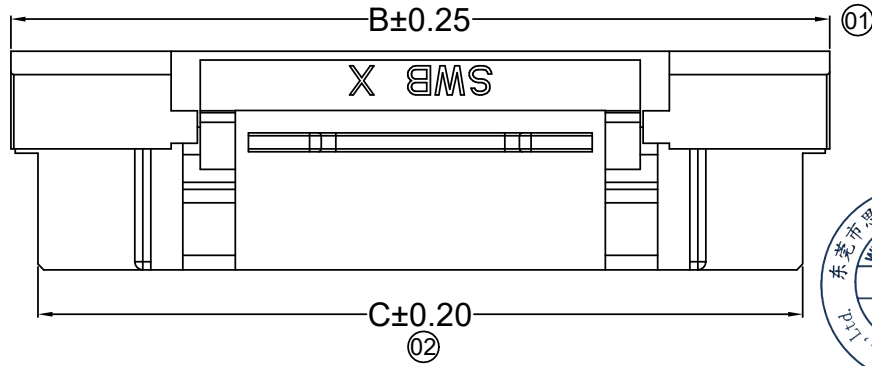

20P Shape Scale 1:1

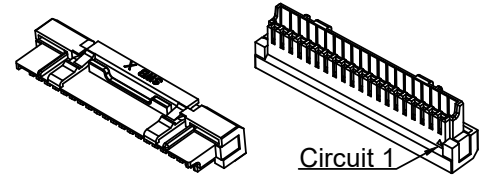
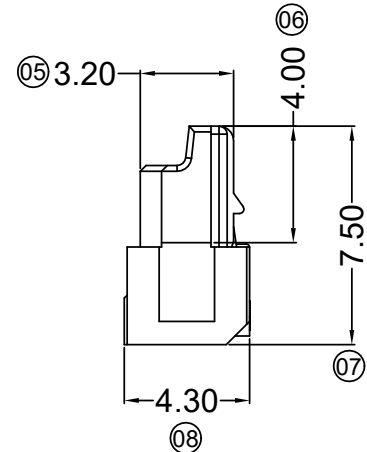
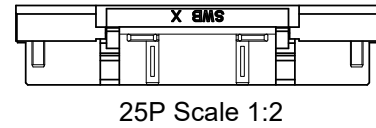
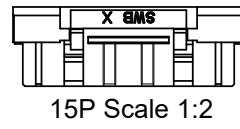
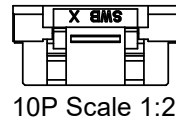
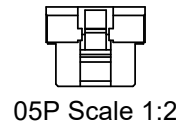
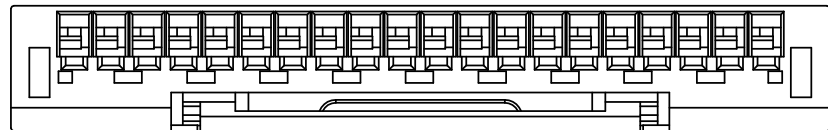

- Specifications :
- Voltage rating: 200V AC / DC
  - Current rating: 1.5A AC / DC
  - Withstanding voltage: 1000V AC/minute
  - Temperature range: -40°C~+130°C
  - Insulation resistance: ≥1000MΩ
  - Contact resistance: ≤20mΩ
  - After environmental testing: ≤40mΩ
  - Suitable SWB Terminal: 1257T
  - Mates With SWB Wafer: 1257W

1257 H X - XX HF - XX XX  
① ② ③ ④ ⑤ ⑥ ⑦

- ① Series No.
- ② Category: H-HSG
- ③ Connector Type: Blank-ordinary
- ④ Row No.-Pin No: XX-05P-25P
- ⑤ RoHS/HF Code: HF-Halogen Free
- ⑥ Plastic material: LP-LCP 94V-0 ; N0-PA66 94V-0;
- ⑦ Color: Blank-Natural Color

Poles	Dimensions(mm)		
	A	B	C
05	5.00	9.35	7.50
10	11.25	15.60	13.75
15	17.50	21.85	20.00
20	23.75	28.10	26.25
25	30.00	34.35	32.50

DATE	REV	ECN NO.	DESCRIPTION	MODIFY	APPROVAL
2020.6.19	E	ER20200623001	Update Drawing Frame	YYting	Robing

GENERAL TOLERANCE

.X	±0.30
.XX	±0.20
.XXX	±0.10
X.°	±2°

PROJECT: Robing

APPROVAL: Robing

CHECK: YYting

DRAWN: Alan

DATE: 2014/06/04



PART NO. 1257H-XXHF-XX

TITLE 1.25mm Crimp Style Connectors

UNIT	SCALE	SHEET	REV	NUMBER
mm	1:1	1/1	E	A-022

1 2 3 4 5 6 7 8

RoHS

This products can apply to the SWB Doc NO. QA-3-04-005 of Environmental&Material Management Rules

Specifications :

- Voltage rating: 200V AC / DC
- Current rating: 1.5A AC / DC
- Withstanding voltage: 1000V AC/minute
- Temperature range: -40°C~+130°C
- Insulation resistance:≥1000MΩ
- Contact resistance: ≤20mΩ
- After environmental testing: ≤40mΩ
- Wire Range:AWG#26-28
- Insulation O.D.:1.07mm(Max)
- Used In SWB Housing:1257H

1257 T X - P SN X - X  
① ②③ ④⑤ ⑥ ⑦

- ① Series Number
- ② Category: T-terminal
- ③ Shape: Blank-ordinary
- ④ Material: P-Phosphor bronze
- ⑤ Plating code:  
SN-Bright tin plating  
V01-All Gold Flash  
V03- 3u" Gold
- ⑥ Plating method: Blank-Stamping before plating
- ⑦ Mold No./ Mark/Special No.

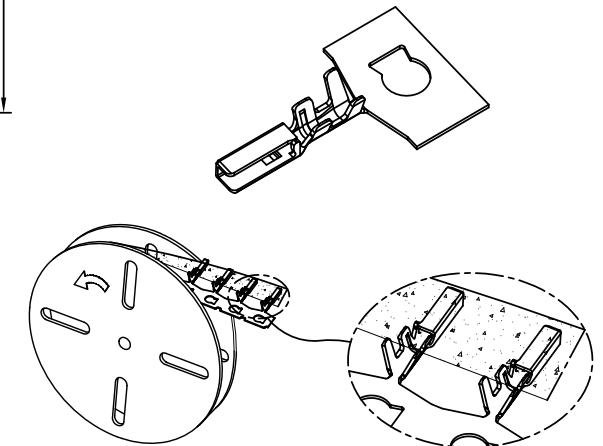
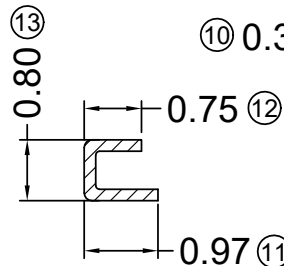
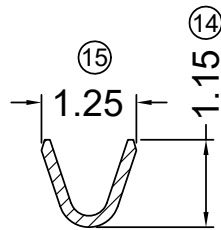
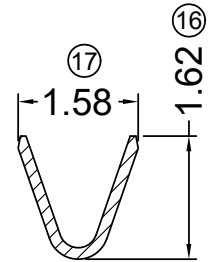
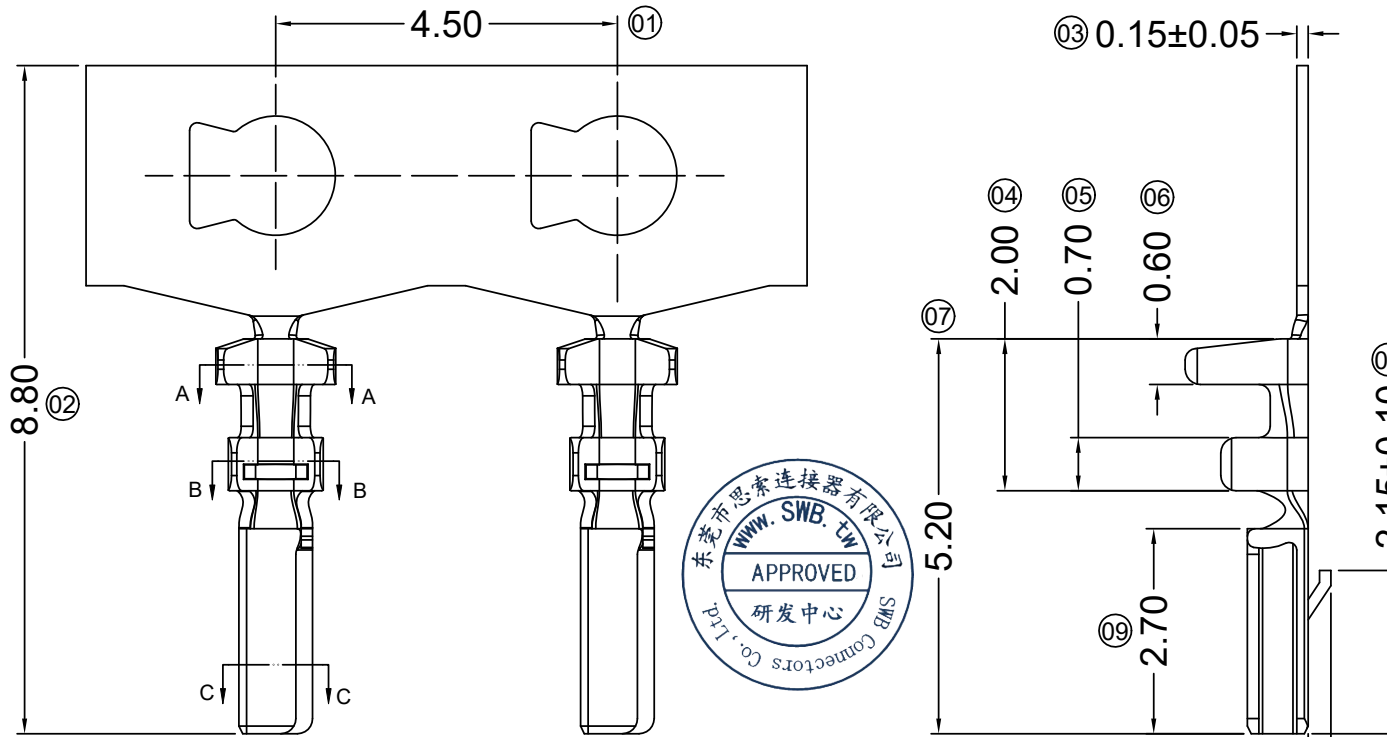

					<p>GENERAL TOLERANCE</p> <p>.X ±0.30</p> <p>.XX ±0.20</p> <p>.XXX ±0.10</p> <p>X.° ±2°</p>				<p>东莞市思索连接器有限公司</p> <p>SWB CONNECTORS CO.,LTD</p>				<p>PART NO. 1257T-PXX</p>																																														
					<p>APPROVAL</p> <p>Robing</p>				<p>CHECK</p> <p>YYting</p>				<p>DRAWN</p> <p>Wuxiaotao</p>				<p>TITLE 1.25mm Crimp Style Connectors</p>																																										
<p>2020.6.19</p>					<p>D</p>					<p>ER20200623001</p>					<p>Update Drawing Frame</p>					<p>YYting</p>					<p>Robing</p>					<p>DATE</p> <p>2014/06/04</p>																													
<p>DATE</p>					<p>REV</p>					<p>ECN NO.</p>					<p>DESCRIPTION</p>					<p>MODIFY</p>					<p>APPROVAL</p>					<p>PROJECT</p> <p>Robing</p>					<p>UNIT</p> <p>mm</p>					<p>SCALE</p> <p>1:1</p>					<p>SHEET</p> <p>1/1</p>					<p>REV</p> <p>D</p>					<p>NUMBER</p> <p>A-014</p>				